



IT'S A BLAST! - WITH OR WITHOUT THE APP

Have fun blasting Target Drone, even if you don't have a phone to connect to. It works with ANY gel bead or foam dart blaster. Just turn it on, toss-launch it into the air and blast away!

Target Drone is even more fun when you connect with the Faction app. Track scores, get blasting stats, customize your target blasting games, and even launch the drone directly from your phone. The Faction app also allows you to fly Target Drone manually, with app screen controls. Take target practice to a whole new level!

CHARGING TARGET DRONE

Press and hold power button to turn ON/OFF

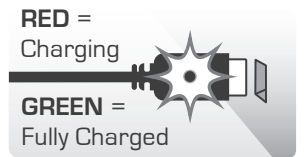
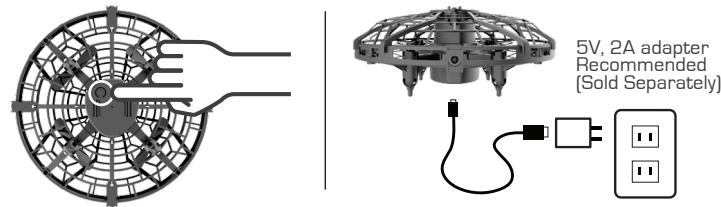

Plug included charging cable into drone and USB power supply.

Charging can take up to 45 minutes and provides approx 7 minutes of flying time. Drone will flash RED when power runs low. Charge back to full power before starting another target practice game.

PLAYING WITHOUT THE APP

No phone, no problem. Turn Target Drone on, toss-launch into the air and start blasting!

TOSS TO LAUNCH

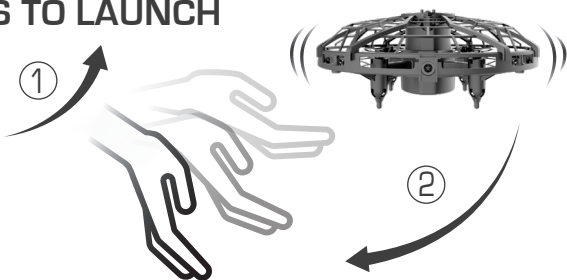

Turn drone on and hold it upright in front of you in the palm of your hand. Keep drone level and give it a slight toss upward, then drop your hand quickly downward. Drone will automatically start to fly. Toss drone high to hover high, toss drone low to hover low.

If drone crashes or you blast it down (way to go!), just pick it up and toss-launch it back into the air.

GRAB TO STOP

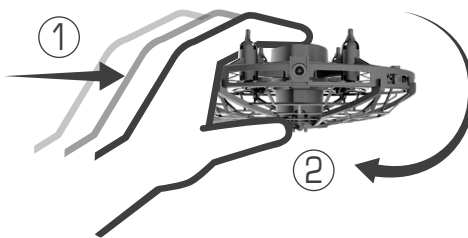

Quickly grab drone and flip upside down to stop. If out of reach, blast drone to make it fall or wait until battery power is depleted. Drone will auto-land itself.

ADJUSTING DIFFICULTY

Tap the power button to toggle between **EASY** (green) and **MEDIUM** (red) difficulty modes. In easy mode, Target Drone moves sporadically higher and lower. Switch to medium mode and Target Drone moves in several directions. Manual adjustment only works when not paired with the app.

Difficulty modes are adjusted through the app whenever Target Drone is connected to the app. Refer to in-app settings for details.

STATUS

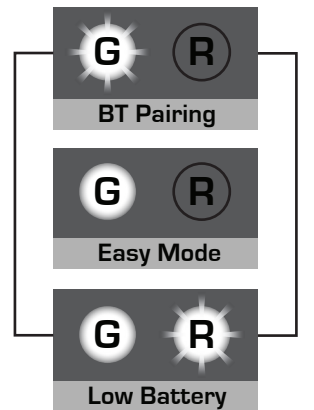

PLAYING WITH THE FACTION APP - 3 BETTER WAYS TO PLAY!

Track scores and stats, customize games, launch from your phone, and fly manually!

Scan or visit FactionBattle.com to download and install the free **Faction Battle System App**. Update your phone to its most current operating system for best performance.

IMPORTANT: It's best to connect with the Faction app at least once after purchase to ensure your drone's best possible performance with automatic app firmware updates.



PAIR TO YOUR PHONE THROUGH THE APP

Ensure your phone's Bluetooth is on. Launch app, then turn drone on to initiate pairing. (If drone is already on, but not FLASHING GREEN, quickly turn off then on again to re-initiate pairing). Follow in-app instructions to select Faction Skyfire. Once paired (light turns solid green and red), drone will auto-pair to your phone whenever both the app is open and drone is turned on. Should pairing fail, turn drone off then on again to re-attempt connection.

IMPORTANT: Target Drone ONLY connects through the app. Target Drone will not appear in your phone's Bluetooth settings. It can only connect when app is open and running and it will automatically disconnect when app is closed.

Follow the same steps to pair with a different phone. Close app on original phone until drone has successfully paired with new phone.



Flashing **GREEN** = Pairing Mode

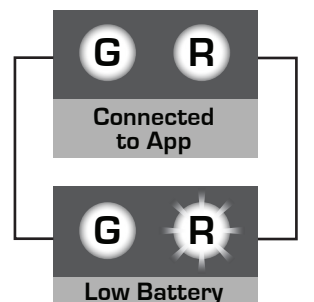
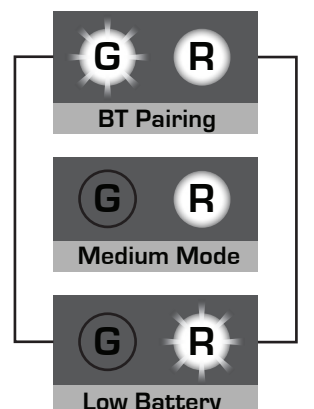
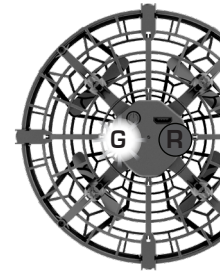

1-PLAYER - TARGET PRACTICE

Blast it down! Target Drone flies itself. Select **Target Practice** → **1-Player with Drone** from main menu. Follow in-app instructions.

Target Drone can be launched through the app when playing app games. Land anytime by pressing the in-app **QUIT** button.

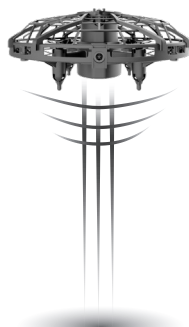

If you crash or blast drone down before game is over, the game will pause until you are able to relaunch. Set drone upright and press the in-app **RELAUNCH** button to continue game. (You may also toss-launch, but app Hover Height Settings may not apply).

2-PLAYER - DRONE vs. BLASTER

Player one shoots while player two flies Target Drone manually. Select **Target Practice** → **2-Player with Drone** from main menu. Follow in-app instructions.

FLY MANUALLY, JUST FOR FUN

Take a break from target practice for a little flying practice. Select **Fly Drone Manually** from main menu. Follow in-app instructions.



NOTE: Drone always flies relative to direction it is facing. Blue is forward.

FLIP BUTTON
Press **FLIP** button, then press right stick in direction you want to flip.

TROUBLESHOOTING

When not using the app, drone is flying too high to grab and turn off.	Blast drone to make it fall or wait until battery power is depleted and drone auto-lands itself.
Rather than hovering, drone flies erratically or immediately flies away in one direction after launch.	- Turn drone off then on again, then quickly place drone upright on a flat level surface for a couple seconds before attempting to relaunch. - Drone works best in still weather conditions. Avoid windy or inclement weather for optimum performance.
Drone slowly falls to the ground after launch or is having trouble launching.	- Inspect drone for obstacles inhibiting air flow. Ensure that there is no hair or debris wrapped around the propellers and that drone is clean of gel bead residue. - Battery power may be running low. Follow instructions for charging.
Drone does not respond when attempting to launch from the app.	- You may be too far away from the drone to launch. Move closer and re-attempt launch. - Drone may not be connected to the app. With the app open and running, turn the drone off then on again to pair then re-attempt launch. - Make sure your phone's Bluetooth is on and the app has permission to use it.
App game stops when drone is shot down or crashes.	The game automatically pauses when it detects that the drone has crashed. Simply relaunch drone to continue game.

Ages 8+

CLEANING TARGET DRONE

Always inspect and clean Target Drone after use with gel bead blasters. Wipe off any residual gel bead material with damp cloth if needed. Do not rinse or submerge. Dried gel residue may adversely affect performance.

UPGRADE YOUR ARSENAL



**20,000
GEL BEAD
AMMO**



**10,000
GLOW IN THE DARK
GEL BEAD AMMO**

**SENTINEL
R/C TURRET
GEL BEAD
BLASTER**



**LEARN MORE ABOUT
FACTION
FACTIONBATTLE.COM**





**HAVOC
GEL BEAD
BLASTER**



**SPECTRE
GEL BEAD
BLASTER**

THIS PRODUCT CONTAINS A LITHIUM-POLYMER BATTERY 3.7V 400mAh (Non-replaceable):

LiPo batteries have a severe risk of fire and injury if they are improperly handled or misused. They may explode, overheat or ignite. Read all following precautions and instructions regarding the care and use of LiPo batteries.

The LiPo battery is only to be used with the drone and charger included with this product.

- Keep away from flammable materials.
- Do not expose to direct sunlight.
- Do not place in a fire or leave in hot places.
- Keep dry and away from water.
- Never throw into a fire or attempt to open outer casing.
- Never charge battery unattended. When charging battery you should always remain in constant observation to monitor the charging process and react to potential problems that may occur.
- Disconnect with the charging wire if the battery is fully charged.
- Never store or charge battery inside the car in extreme temperatures, since extreme temperature could ignite fire.
- Use caution to avoid puncture of the battery. Puncture of battery may cause a fire.

LiPo Battery Disposal: LiPo batteries must be recycled or disposed of properly. They should not be disposed of with other household waste. Check your local laws and regulations for correct recycling and/or battery disposal.

ADULT SUPERVISION REQUIRED:

Read all enclosed instructions, warnings and precautions regarding the care and use of LiPo batteries. An adult should periodically check this product to ensure no damage or hazards exist. Spinning blades can cause injury. Adequate flying space is required. Keep a safe distance away from streets, public thoroughfares, bodies of water and powerlines. Be mindful of spectators. Read all enclosed information before operating.



IMPORTANT: Be mindful when shooting at Target Drone. Never aim at people or animals. Always wear eye protection when using gel bead blasters. Avoid bright sunlight and windy conditions.

**Questions or comments?
Please email
support@skyrockettoys.com**

This device complies with PART 15 of the FCC Rules. Operation is subject to the following two conditions. [1] This device may not cause harmful interference, and [2] this device must accept any interference received, including interference that may cause undesired operation.

CAUTION: Changes or modifications to this unit not expressly approved by the party responsible for compliance could void the user's authority to operate the equipment.

NOTE: This equipment has been tested and found to comply with the limits for a Class B digital device, pursuant to Part 15 of the FCC rules.

These limits are designed to provide reasonable protection against harmful interference in a residential installation. This equipment generates, uses and can radiate radio frequency energy and, if not installed and used in accordance with the instructions, may cause harmful interference to radio communications. However, there is no guarantee that interference will not occur in a particular installation. If this equipment does cause harmful interference to radio or television reception, which can be determined by turning the equipment off and on, the user is encouraged to try to correct the interference by one or more of the following measures: Reorient or relocate the receiving antenna - Increase the separation between the equipment and receiver - Connect the equipment into an outlet on a circuit different from that to which the receiver is connected - Consult the dealer or an experienced radio/TV technician for help.

SKYROCKET TOYS 30-DAY LIMITED WARRANTY

Skyrocket warrants to the original purchaser that this product is free of defects in materials or workmanship for 30 days from the original purchase. This warranty only applies to defects in material and workmanship and is not valid if the product has been misused or not assembled and maintained per instructions. Proof of defect or malfunction must be provided and verified, along with original sales receipt with date. For quickest resolution, defective product should be returned to the original point of purchase for exchange or refund. If you have questions or difficulties, please contact Skyrocket Toys customer service department at support@skyrockettoys.com.

WARNING: This produces flashes that may trigger epilepsy in sensitized individuals.

Google Play is a trademark of Google Inc. - Apple, the Apple logo, the iPhone and the App Store are trademarks of Apple Inc., registered in the U.S. and other countries. The App Store is a service mark of Apple Inc.

©2023 Skyrocket LLC, Los Angeles, CA 90292 USA. All Rights Reserved. Faction and the Skyrocket logo are trademarks of Skyrocket LLC. Other trademarks and trade names are those of their respective owners, and there is no relationship express or implied with Skyrocket LLC.

MADE IN CHINA



ITEM # 18589 FCC ID: 0531858924G

SKYROCKET®